

FAB32RBL5UK



Product Family	Refrigerators
Installation	Free Standing
Category	Bottom Mount
No-Frost system	Total
Cooling type	Total No Frost - Double Cooling system
Defrost	Automatic
Hinge type	Standard
Hinge position	Right
EAN code	8017709298241



Aesthetics



Colour	Black	Side material	Steel
Finishing	Gloss	Side colour	Black
Aesthetics	50's Style	Logo	Applied
Design	Rounded	Door shelves profile colour	Chrome
Material	Heat-moulded	Drawers profile colour	Chrome
Handle	External	Colour of glass shelf profile	Chrome
Handle type	Fixed	Display	LED
Handle colour	Chrome	Display position	Interior (on the top)
Logo colour	Chrome	Colori disponibili	Orange, Pastel blue, White, Blue, Black, Cream, Pink, Red, Silver, Pastel green, Lime green

Refrigerator compartment features



No. of adjustable shelves	2	Type of crisper/vegetable drawers cover	Glass
Number of fruit and vegetables drawers	1	Life Plus zone-0°C	0°C
Type of adjustable shelves	Glass	Internal light in fridge	Yes
		Type of internal light (fridge)	LED

Type of crisper/vegetable drawers cover Standard

Crisper Cover Yes

Refrigerator Inner Door

No. of door shelves with transparent cover 1

Number of adjustable door shelves 2

Adjustable door shelves with wire support Yes

No. of bottle shelves 1

Bottle shelves with wire support Yes

Other Refrigerator features



MultiFlow Yes

Fan Yes

Freezer compartment features

Number of drawers 3

No. of compartments with flap 1

Type of shelves Glass

Other Freezer features



Fast freezing compartment Yes

Other technical features

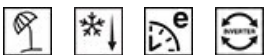

Functions display

Holiday, Fast freezing, Fast cooling, ECO, Temperature alarm

Fast freezing button

Yes

Power on lamp

Yes

Temperature alarm lamp

Yes

Door open alarm

Acoustic and visual

Temperature Alarm

Yes

Type of temperature control

Electronic

No. of compressors

1

Refrigerant gas type

R600a

Type of compressor

Variable Speed Compressor

Refrigerant Quantity (gr)

60 g

Foam agent

Cyclopentane

Performance / Energy Label



Category of the household refrigerating appliance model	Refrigerator - freezer
Noise level	37 dB(A) re 1pW
Energy efficiency class	A+++
Energy efficiency Index EEI	21.3 %
Annual energy consumption	178 KWh/year
Climatic class	SN, N, ST, T
Fresh Food compartment - Storage Volume	204 l
Total gross volume	350 l

Chiller compartment net volume	30 l
Storage volume frozen food compartment	97 l
4 Star compartment - Star rating	4
Freezing capacity	6 Kg/24h
Total storage volume	331 l
Thaw time	40 h
Gross volume fresh food compartment	231 l

Performance / Energy Label NEW



Annual energy consumption	204 KWh/year
Energy efficiency class	D
Airborne acoustical noise emission class	C
Total volume	331 l
Sum of the volumes of the frozen compartment(s)	97 l

Sum of the volumes of the chill compartment(s) and the unfrozen compartment(s)	234 l
Thaw time	40 h
4 star - Freezing capacity	6 Kg/24h
Climatic class	SN, N, ST, T
EEI	80 %

Electrical Connection

Plug	(G) UK e Singapore
Nominal power	127 W
Current	0.8 A

Voltage (V)	220-240 V
Frequency (Hz)	50/60 Hz
Power supply cable length	180 cm

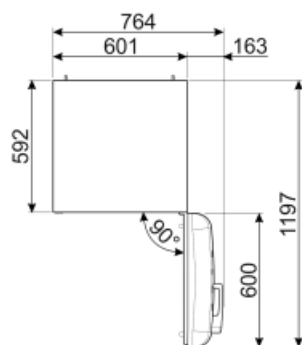
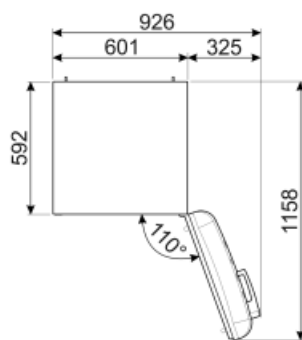
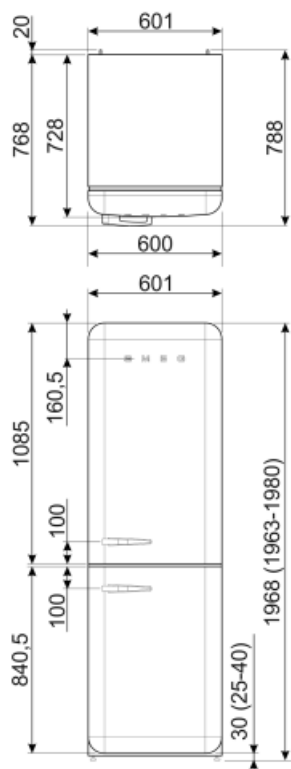

Alternative products



FAB32RCR5UK

Hinge position: Right
Cream



FAB32LCR5UK

Hinge position: Left
Cream



FAB32LBL5UK

Hinge position: Left
Black



FAB32RRD5UK

Hinge position: Right
Red



FAB32LRD5UK

Hinge position: Left
Red



FAB32RPB5UK

Hinge position: Right
Pastel blue



FAB32LPB5UK

Hinge position: Left
Pastel blue



FAB32RPG5UK

Hinge position: Right
Pastel green



FAB32LPG5UK

Hinge position: Left
Pastel green



FAB32RWH5UK













Hinge position: Right
White



FAB32LWH5UK

Hinge position: Left
White

Symbols glossary

- | | | | |
|--|--|--|---|
|  | 4 stars freezing compartment for better food preservation. |  | The automatic defrost system works by automatically defrosting at regular intervals eliminating the need to defrost altogether. |
|  | LED display: to show programmes, functions and options selected and the time to the end of the cycle. |  | Economical mode: Analyzes fridge functioning during the activation and optimizes the operating cycle in order to reduce power consumption. |
|  | Energy efficiency class D |  | A+++: Appliances with this symbol can reduce energy consumption by a further 30% from the standard A energy rating. |
|  | Ventilated: Forced distribution of cold air in the refrigerator compartment, which allows even temperature distribution within the fridge. |  | Fast freezing: The fast freezing function brings the temperature of the compartment down when activated a few hours prior to usage. |
|  | Power saving mode: The power saving mode allows you to disable the refrigerator and keep the freezer working. |  | LED interior lighting: is a more energy efficient and long lasting way of illuminating the interior of the appliance. |
|  | Life Plus 0°C: The temperature in the Lifepius compartments is kept at 0°C, which preserves fresh meat and fish longer. |  | Inverter technology: The evolution of Smeg's driers towards more intelligent and environmentally sustainable models has led to the choice of using Inverter technology with heat pumps, which reduces significantly energy consumption. |
|  | Air plus: keeps food fresher for longer. | | |