

FMI020X

Usable volume

20 l



Product Family

Microwave

Category

Built-in

Installation

With frame

Power supply

Electric

Cooking Method

Microwave with grill

Control

Electromechanical



Programs / Functions

No. of functions

5

Full grill



Defrost by time



Defrost by weight



Microwave



Microwave + grill



Automatic programmes

8

Other Microwave functions

Multi-session cooking

Controls

Display / Clock

1 a LED

Type of control setting

Control knobs / buttons

Opening

Mechanical button

No. of controls

1

Control knobs

Push-push

Controls colour

Steel effect

Buttons Colour

Steel effect

Options



Timer

Electronic

Time-setting options

End cooking

Controls Lock / Child Safety

Yes

Quick start option

Yes

End of cooking acoustic alarm Yes

Technical Features



Cavity material	Stainless steel	Door opening	Side-opening
No. of lights	1	Total no. of door glasses	1
Light type	Led	Safety Thermostat	Yes
Turntable	Yes	Cooling system	Tangential
Turntable dimensions	24,5 cm	Microwave screen protection	Yes
Light when door is opened	Yes	Microwave stops when door is opened	Yes
Grill type	Heating element	Usable cavity space dimensions (HxWxD)	218x315x295 mm
Grill - power	1000 W	Microwave effective power	800 W

Accessories Included







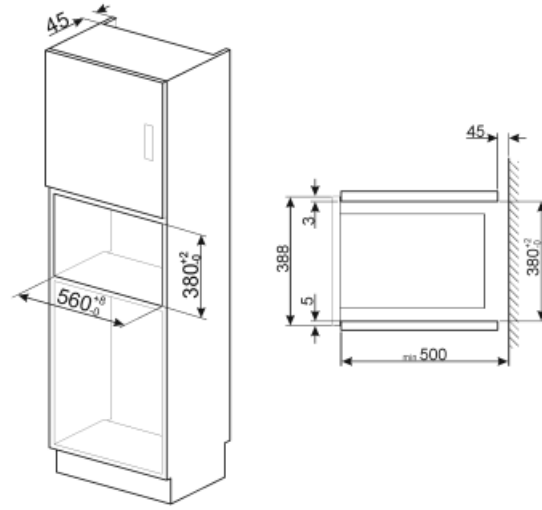
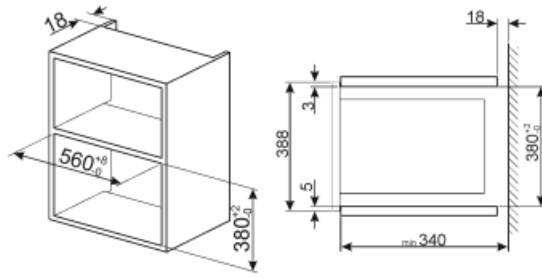
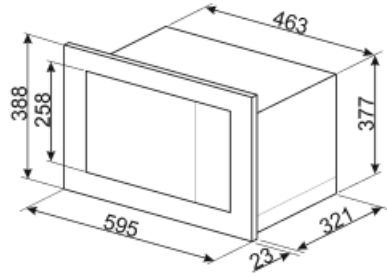

Grid	1	Frame	Yes
-------------	---	--------------	-----

Electrical Connection

Nominal power	1250 W	Frequency (Hz)	50 Hz
Current	5,4 A	Power supply cable length	150 cm
Voltage (V)	230 V		



Symbols glossary (TT)

- | | | | |
|--|---|--|--|
|  | Child lock: some models are fitted with a device to lock the programme/cycle so it cannot be accidentally changed. |  | Microwave energy shortens cooking times dramatically and produces energy savings. |
|  | Defrost by time: Manual defrost function. At the end of the set duration, the function stops. |  | Defrost by weight: Automatic defrost function. You choose the type of food to defrost from the available categories (MEAT - FISH - BREAD - DESSERTS) After entering the weight of the food, the oven automatically defines the time required for proper defrosting. |
|  | Grill: Very intense heat coming only from above from a double heating element. The fan is not active. Provides excellent grilling and gratinating results. Used at the end of cooking, it gives a uniform browning to dishes. |  | Microwave: Penetrating straight into the food, microwaves cook very quickly and with considerable energy savings. Suitable for cooking without fat, they are also able to thaw and heat food without altering its original appearance and aroma. The microwave function can also be combined with conventional functions with all the resulting advantages. Ideal for all types of food. |
|  | Microwave + grill element: The use of the grill results in a perfect browning of the surface of the food. The action of microwaves allows instead of cooking in a short time the internal part of the food. |  | Side lights: Two opposing side lights increase visibility inside the oven. |
|  | The capacity indicates the amount of usable space in the oven cavity in litres. | | |