

# STL333CL



<b>Product Family</b>	Dishwashers
<b>Finishing</b>	Silver
<b>Width</b>	60 cm
<b>Commercial height</b>	82 cm
<b>Installation</b>	Fully-integrated built-in
<b>Kitchen panel</b>	Not supplied
<b>N° baskets</b>	3, FlexiDuo
<b>Motor</b>	Inverter 2.0
<b>EAN code</b>	8017709307011



## Programs / Functions



<b>No. of programmes</b>	10+1	<b>Auto sensor 45-65</b>	Yes
<b>Washing temperatures</b>	38, 45, 50, 55, 65, 70, 75 °C	<b>Mix</b>	Yes
<b>Soak</b>	Yes	<b>Quiet (-2 dB)</b>	Yes
<b>Express 27'</b>	Yes	<b>Intense</b>	Yes
<b>Crystal</b>	Yes	<b>Self clean</b>	Yes
<b>Full express - 60 minutes</b>	Yes	<b>Hygiene 99,9%</b>	Yes
<b>ECO</b>	Yes		

## Options



<b>Dry Assist+ option</b>	Yes	<b>1/2 load FlexiZone option (varied distribution)</b>	Yes
<b>Delay timer option</b>	Up to 24 hours, with automatic soak	<b>Special programs option</b>	Yes

## Baskets



<b>Basket colour</b>	Grey	<b>Upper basket with EasyGlide System</b>	Yes
<b>Basket components colour</b>	Grey	<b>Largest loadable dish in upper basket</b>	19,0 cm

<b>Handle</b>	In plastic with stainless steel insert on upper and lower basket	<b>Lower Basket</b>	With 2 foldable racks
<b>Upper Basket</b>	With 1 foldable rack	<b>Lower basket with anti-drip inserts</b>	Yes
<b>Glass holder</b>	Yes	<b>Largest loadable dish in lower basket</b>	30,0 cm
<b>Height adjustment of the upper basket</b>	On three levels	<b>Colour Inner Components</b>	Blue

## Technical Features



<b>Width (mm)</b>	598 mm	<b>Water supply</b>	Single; cold/hot water max. 60°C - energysave with hot water up to 35%
<b>Depth (mm)</b>	545 mm	<b>Max water hardness</b>	100°FH;58°dH
<b>Display type</b>	3 digit	<b>Drying system</b>	Natural condenser drying, with Dry Assist + automatic door opening system at the end of the cycle
<b>Product Height (mm)</b>	818 mm	<b>Steam protection</b>	In plastic
<b>Controls</b>	Electronic	<b>Tank material</b>	Stainless steel
<b>Display</b>	Delayed start, Programme time indicator, Time to end indication	<b>Filter</b>	Stainless steel
<b>Programme graphics</b>	Symbols	<b>Concealed heating element</b>	Yes
<b>On/off indicator</b>	Yes	<b>Hinges</b>	Self balancing, Sliding, FLEXIFIT
<b>Salt light indicator</b>	Light	<b>Min. and max. frontal panel weight</b>	2 - 11 kg
<b>Rinse aid indicator</b>	Light	<b>Min. and max plinth height</b>	50 - 215 mm
<b>End of cycle indicator</b>	ActiveLight	<b>Adjustable feet</b>	7cm, from 820 to 890 mm
<b>Washing system</b>	Planetarium	<b>Additional gaskets</b>	Yes, with stainless steel plate
<b>Third spray arm</b>	Single	<b>Back cover</b>	Yes
<b>Water softener</b>	With electronic setting	<b>Depth of dishwasher with open door (mm)</b>	1146
<b>Turbidity sensor Aquatest</b>	Yes	<b>Back feet adjustable from front</b>	Yes
<b>Flood protection system</b>	Total Acquastop	<b>Top cover</b>	In plastic

## Performance / Energy Label NEW

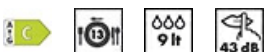

<b>Energy Efficiency Class (Washing cycle)</b>	C	<b>Programme duration</b>	4:25 h:min
<b>Energy consumption [per 100 cycles, based on the eco programme]</b>	73 KWh	<b>Airborne acoustical noise emissions (spinning phase)</b>	43 dB(A) re 1 pW
<b>Rated capacity (ps)</b>	13	<b>Airborne acoustical noise emission class</b>	B
<b>Water consumption [per cycle]</b>	9.0 litres	<b>Energy efficiency Index (EEI) (Washing cycle)</b>	43.8

## Electrical Connection

<b>Plug</b>	(F;E) Schuko	<b>Frequency (Hz)</b>	50 Hz
<b>Connected power</b>	1800 W	<b>Type of connection</b>	Single-phase
<b>Current</b>	10 A	<b>Power supply cable length</b>	140 cm
<b>Voltage</b>	220-240 V		

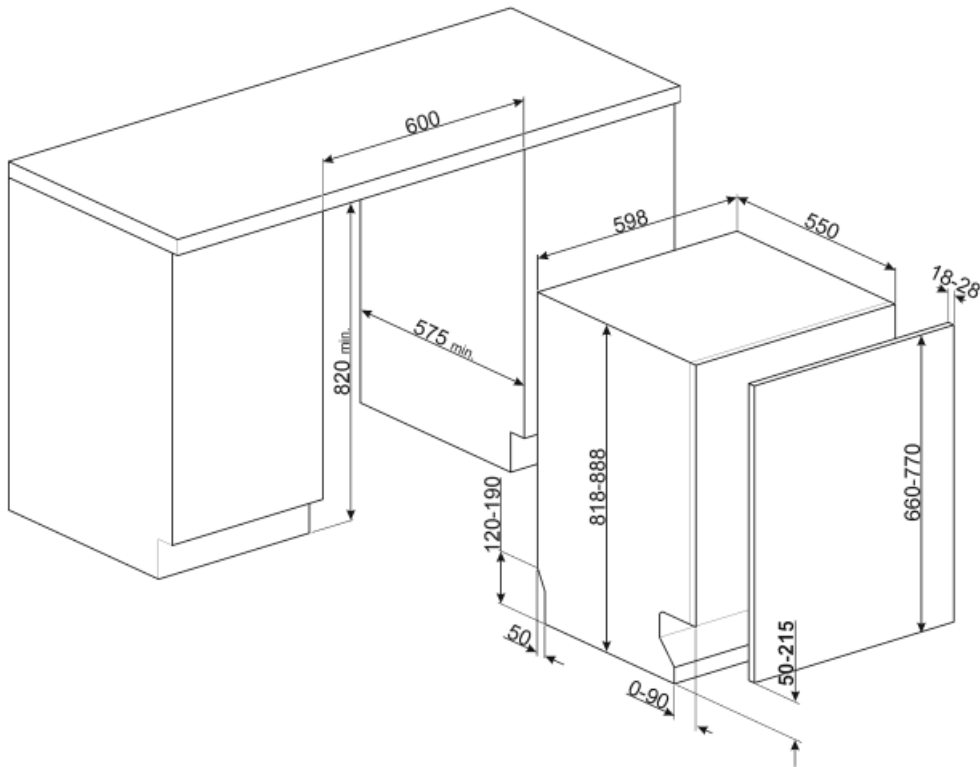

## Not included accessories

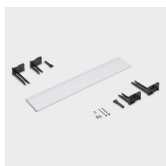

### KITPL60B

Toekick Kit in White colour with adjustable height and deepness. Can be installed over all the fully integrated and underbench models with variable fulcrum or flexifit hinges.



### KITPL60N

Toekick Kit in Black colour with adjustable height and deepness. Can be installed over all the fully integrated and underbench models with variable fulcrum or flexifit hinges.



### KITPL60X

Toekick Kit in Stainless Steel with adjustable height and deepness. Can be fitted over all the fully integrated and underbench models with variable fulcrum or flexifit hinges.

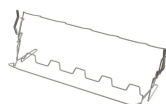

### KITGH

Kit glass holder. It has to be fitted on the first basket but only if there are foldable racks



### KITPLV2

Kit extension for dishwasher and washing machine: length mt. 2



### KITFLEXI



### KIT82CX



### KIT86PORTAN-1



























### KIT86PORTWH-1



### KIT86PORTX-1

## Symbols glossary

	Activelight is an led light which projects a red spot onto the floor beneath the dishwasher when the appliance is in use.		Aquatest measures the clarity of the water during an auto program, and automatically ensures the minimum consumption of water and energy.
	Anti-drip: Some models of dishwashers are equipped with special polymer nozzles anti-drip, that improve the process of drying.		COMM_HEIGHT_82_72dpi
	Delay Timer: The delay timer can postpone the start of the program by up to 24 hours.		EasyGlide: Convenient EasyGlide system for easy unloading of the appliance that allows reaching maximum flexibility of load of the machine.
	FlexiDuo: The FlexiDuo 3rd cutlery basket allows you to arrange cutlery or small cups, ladles, or bulky utensils however you like: it consists of two separate and moveable modules.		Models with new Flexi Fit hinges are able to be installed in kitchens with a plinth of just 5cms. With this new hinge design, the panel has a sliding movement from the bottom to the top, avoiding any possible interference of the panel with the plinth.
	FlexiZone: The 1/2 load flexizone allows you to wash a reduced load saving energy, water and time and there are no restrictions on where the items are placed.		Noise Level: Excellent insulation and special devices keep noise to a minimum.
	PLANETARIUM_WASHING_SYSTEM_72dpi		Auto 45°- 65°: The auto programme regulates the length of a cycle depending on the need for a pre-wash and the number of rinses required.
	Crystals: The Crystals programme is dedicated to delicate dishes such as glasses and china.		Eco: Eco, this economic wash programme uses a low amount of water and energy in order to provide the most environmentally friendly cleaning option.
	Normal programme: The normal programme is suitable for normal degrees of dirt for everyday use.		Soak programme: The soak programme provides a rinse to prevent dirt from drying.
	Rapid 27 Mins: The rapid 27 mins quick program takes just 27 minutes to wash a load.		Ultraclean: The Ultraclean option performs a final rinse at a high temperature of 70°C eliminating virtually all bacteria.
	The symbols show the number of plate settings of the dishwasher.		Total Acquastop: In addition to the partial Acquastop protection present in all Smeg dishwashers, some models have an electronic device fitted to the water intake hose, which monitors water levels in the machine, detects leaks in the hose and switches off the water supply immediately when necessary.
	System WaterSave ensures the best washing results with minimal water consumption depending on the model of dishwasher.		...
	...		...



...



The Dry Assist + option, in addition to saving energy, ensures perfect drying of the dishes by opening the door automatically at the end of the wash cycle



Energy efficiency class C



**HYGIENE 99.9%** High-temperature washing programme. The 75° rinse guarantees the removal of 99.9% of germs and bacteria, making it ideal for sanitising



The work aimed at continuous improvement has allowed the creation of the second generation of the Inverter motor 2.0, characterised by greater efficiency and durability over time, which allows very high performance and a lower energy consumption and noise level.