

SI5632D



Product Family	Hob
Built-in	Ultra-low profile or Fully Flushed
Dimensions	60 cm
Power supply	Electric
Type	Induction
EAN code	8017709262976



Aesthetics



Aesthetics	Universal
Colour	Black
Finishing	Glass
Material	Glass
Glass Type	Ceramic
Glass edge	Straight edge
Type of control setting	Touch control
Slider	Red
Control knobs position	Front
Serigraphy colour	Grey

Programs / Functions



Total no. of cook zones	3
No. of induction cook zones	3
No. of cooking zones with booster	3
Main on/off switch	Yes
Power levels	14

Options



Standard cut out	490x560 mm	Residual time indicator	Yes
------------------	------------	-------------------------	-----

End cooking timer	3	Limited Power Consumption Mode	Yes
Pause option	Yes	Limited Power Consumption Mode in W	1500, 2000, 2500, 3000, 3500, 4000, 4500, 5000, 6000, 7200 W
Minute minder	3	Show Room Demo Option	Yes
End of cooking acoustic alarm	Yes	Control Lock / Child Safety	Yes

Technical Features



Front left - Induction - single - 2.30 kW - Booster 3.70 kW - Ø 21 cm

Rear left - Induction - single - 1.40 kW - Booster 2.50 kW - Ø 14.5 cm

Front right - Induction - giant - 1.80 - 2.80 kW - Booster 3.50 - 3.60 kW - Ø 18/28 cm

Automatic setting according to pan dimension	Yes	Automatic switch off when overflow	Yes
Automatic pan detection	Yes	Eco-Heat	Yes
Minimum pan diameter indication	Yes	Eco-Off	Yes
Automatic switch off when overheat	Yes		

Electrical Connection

Nominal power (W)	7200 W	Frequency (Hz)	50/60 Hz
Voltage (V)	220-240 V	Power supply cable length	150 cm
Type of electric cable	Single phase	Terminal Box	5 poles

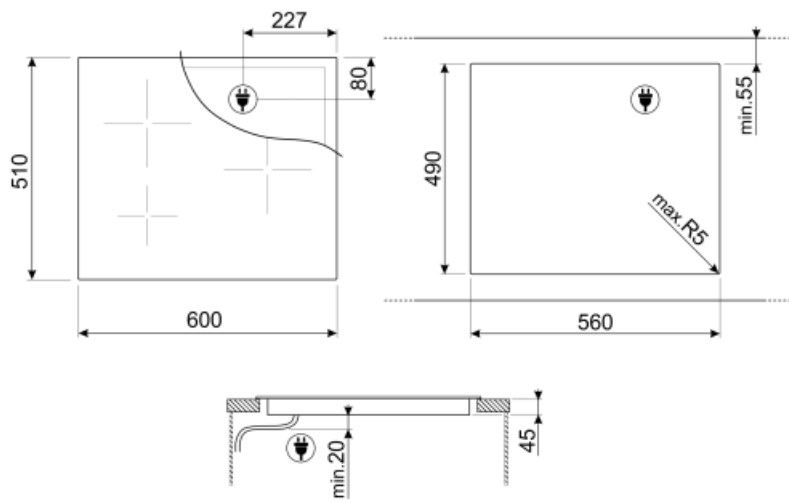

Not included accessories



TPK













Stainless steel grill plate to cook
Teppanyaki dishes



SCRP

Induction and ceramic hobs and
teppanyaki scraper

Symbols glossary

	Power booster: option allows the zone to work at full power when very intense cooking is necessary.		Child lock: some models are fitted with a device to lock the programme/cycle so it cannot be accidentally changed.
	Eco-Heat: this function warns when the zone is still hot after being switched off. As well as ensuring maximum safety by preventing burns, this also allows you to make use of residual heat to continue cooking or keep foods hot.		ECO-logic: option allows you to restrict the power limit of the appliance real energy saving.
	Eco-Off: This energy-saving function shuts the zone down before the timer sounds, making use of the residual heat in the pan.		Giant zone: The giant zone offers extra space and flexibility.
	Overheat protection: The safety system that automatically turns off the hob in case of overheating of the control unit.		Induction: The work of these hobs is based on the principle of electromagnetic induction. The heat is generated directly in the bottom of the pan during its contact with the hob.
	Overfill protection: The special overfill protection shuts down the stove in the presence of overflow of liquids.		PAUSE_72dpi
	Time elapsed: shows how long the cooking zone has been in use.		Timer: All ceramic hobs have a timer which automatically ends cooking after a preset time.
	Touch control		