

## SBS63XNSG



Product Family	Refrigerator
Installation	Free Standing
Category	Side-by-side
Reference width	Higher than 80
Reference height	160 - 200
No-Frost system	Total
Cooling type	Fan assisted refrigerator, no-frost freezer
Defrost	Automatic
Hinge type	Standard
EAN code	8017709329006



## Aesthetics



Aesthetics	Universal	Side material	Steel
Colour	stainless steel-look	Side colour	Silver
Design	Flat	Logo	Applied
Material	Steel Effect	Drawers profile colour	Silver
Handle	External	Colour of glass shelf profile	Silver
Handle type	Fixed	Display	LED
Handle colour	Stainless steel	Display position	External (on door)
Logo colour	Chrome		

## Refrigerator compartment features



No. of adjustable shelves	3	Type of crisper/vegetable drawers cover	Glass
Number of fruit and vegetables drawers	2	Life Plus zone-0°C	Yes
Type of adjustable shelves	Glass	Internal light in fridge	Yes
Type of crisper/vegetable drawers cover	Standard	Type of internal light (fridge)	LED
Crisper Cover	Yes		

## Refrigerator Inner Door

Number of adjustable door shelves 4

No. of bottle shelves 1

## Other Refrigerator features



Accessories Egg tray  
Natural Plus Blu Light Yes  
MultiFlow Yes

Fan Yes  
Antibacterial odour filter Yes

## Freezer compartment features

Number of drawers 2  
No. of shelves 4  
Internal light in freezer Yes

Type of internal light (freezer) LED  
Type of shelves Glass

## Freezer Inner Door

No. of adjustable door shelves 4

## Other Freezer features



Manual ice maker Yes  
Ice maker Manual

Fast freezing compartment Yes

## Other technical features



Functions display

Holiday, Fast freezing, Fast cooling, ECO, Control lock, Temperature alarm

Fast freezing button

Yes

Door open alarm

Yes

Temperature Alarm

Yes

Type of temperature control

Electronic

No. of compressors

1

Refrigerant gas type

R600a

Foam agent

Cyclopentane

## Performance / Energy Label NEW

Total volume 580 l

Sum of the volumes of the frozen compartment(s) 212 l

Sum of the volumes of the chill compartment(s) and the unfrozen compartment(s) 368 l

## Electrical Connection

Plug (F;E) Schuko  
Nominal power 150 W  
Current 0.85 A



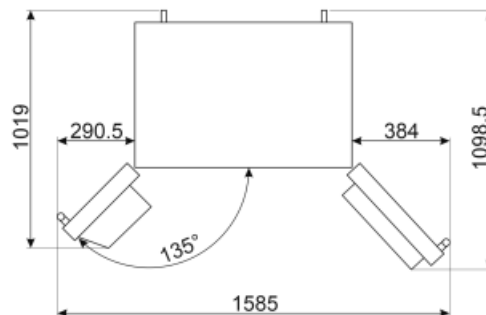
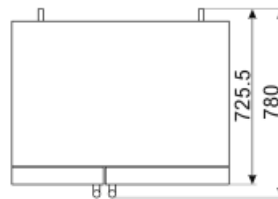
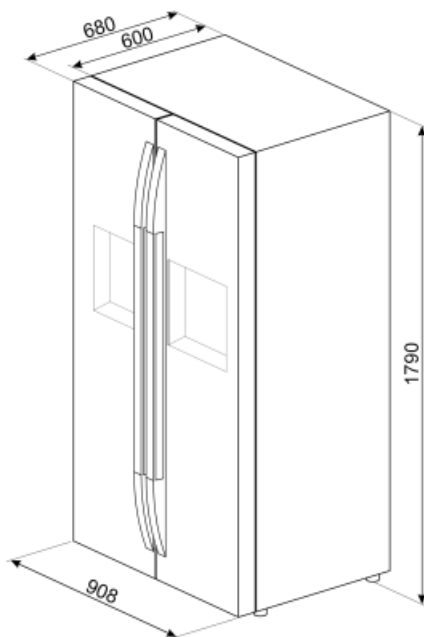









Voltage (V) 230 V  
Frequency (Hz) 50 Hz  
Power supply cable length 215 cm



---

## Symbols glossary

---

	The automatic defrost system works by automatically defrosting at regular intervals eliminating the need to defrost altogether.		Child lock: some models are fitted with a device to lock the programme/cycle so it cannot be accidentally changed.
	LED display: to show programmes, functions and options selected and the time to the end of the cycle.		Economical mode: Analyzes fridge functioning during the activation and optimizes the operating cycle in order to reduce power consumption.
	Ventilated: Forced distribution of cold air in the refrigerator compartment, which allows even temperature distribution within the fridge.		Fast freezing: The fast freezing function brings the temperature of the compartment down when activated a few hours prior to usage.
	Power saving mode: The power saving mode allows you to disable the refrigerator and keep the freezer working.		LED interior lighting: is a more energy efficient and long lasting way of illuminating the interior of the appliance.
	Life Plus 0°C: The temperature in the Lifeplus compartments is kept at 0°C, which preserves fresh meat and fish longer.		Air plus: keeps food fresher for longer.
	Natural Plus Blu Light: This unique Natural Plus Blu Light system works with nature to increase the storage time of fruit and vegetables.		No Frost: The No Frost and Frost free systems prevent ice from forming so that no defrosting is required.