









WDN854SLDSG

EAN Code	8017709340421
Product Family	Washer dryer
Commercial width	60 cm
Commercial depth	Standard capacity
Installation	Free-standing
Load type	Frontal



Programmes

Controls	Electronic
Programmes graphics	Written in EN
No. of programmes	15
Programmes	

Cotton 5kg	Eco 40-60	Express
Synthetic dry	Wool/Hand wash	 Cotton
 Anti-allergy	Cotton Dry	 Drain + Spin
 Mix	 Quick Wash 14 min	 Rinse
 Shirts	 Synthetics	

Washing Temperature

Cool	20°C	30°C
40°C	50°C	60°C
70°C	80°C	90°C

Rated capacity washing cycle 8 kg

Rated capacity complete cycle 5 kg

Weighted energy consumption lavaggio 47 kWh

weighted energy consumption (ciclo completo) 264 kWh

Water consumption (washing cycle) 46 litre

Spin-drying efficiency class B

Airborne acoustical noise class B







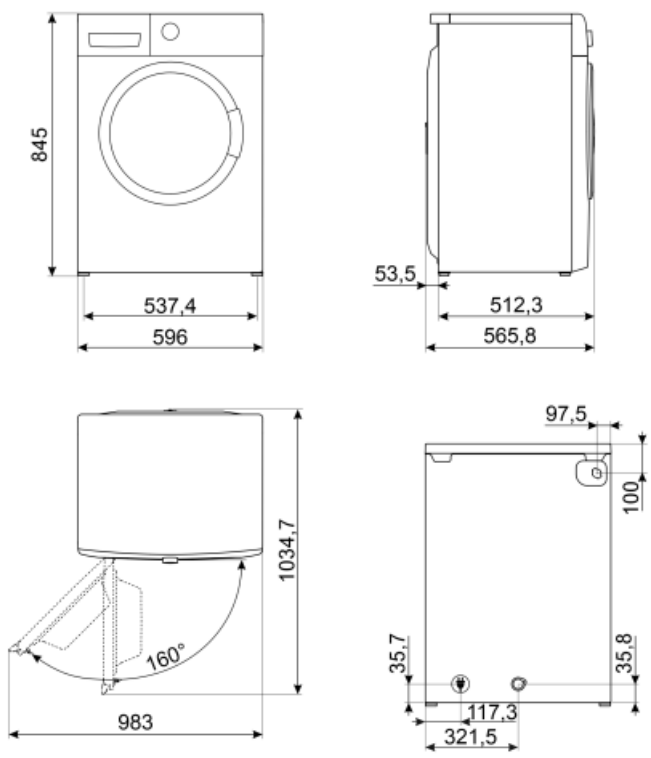









Airborne acoustical noise 76 dB(A) re 1 pW

Programme duration at rated capacity 3:38 h:min

Programme duration at rated capacity 8:30 h:min



Symbols glossary

- | | | | |
|--|--|---|---|
|  | Easy Iron: this is an option which can be selected to ensure the finished laundry is left with less creases to make ironing easier. |  | Variable load: In all models of washing machines is present the system of variable load, according to which the machine automatically diversifies the wash cycle and the time of operation depending on the quantity and type of laundry introduced, allowing a significant saving of water and energy power, up to 30% compared to the versions with fixed load. |
|  | Automatic Load Balancing: provides an ideal distribution of laundry in the drum. In case if the imbalance is detected, the rotation speed starts being controlled in such way to evenly redistribute laundry in the drum, and thus reduce vibration. |  | Child lock: some models are fitted with a device to lock the programme/cycle so it cannot be accidentally changed. |
|  | LCD display: to optimize performance and simplify the use of the appliance. |  | 33 cm: Large loading hatch of 30-32-33 cm in diameter, makes laundry loading and unloading easier and faster with maximum ease of use. |
|  | Gentle drying: program designed to get laundry ready for easy ironing. |  | This option advises when the periodic cleaning of the filters is needed, in order to avoid forgetfulness and thus guarantee the perfect functioning of the dryer over time. The convenient position of the filters makes maintenance fast and extremely simple. |
|  | Inverter technology: The evolution of Smeg's driers towards more intelligent and environmentally sustainable models has led to the choice of using Inverter technology with heat pumps, which reduces significantly energy consumption. |  | Prewash: program designed for heavily soiled garments. |
|  | Antiallergic: Antiallergic program with particular attention to the total removal of residual detergent. |  | Cotton: For soiled fabrics in cotton |
|  | To drain the water in the machine. |  | Mixed fabrics: this cycle is designed for lightly soiled laundry in a mix of cottons and synthetics, or can be used just to refresh stored items. |
|  | Super fast 14 min.: a programme designed to wash small amounts of laundry fast, ideal for washing lightly soiled garments. |  | Extra rinse: The Extra rinse option: can be added to the selected programme when more thorough cleansing of special fabrics is needed. |



Shirts: a cycle to wash shirts in a short time with the utmost care, using a delicate spin for easy ironing.



Synthetics: to wash your synthetic clothes (shirts, blouses, synthetic/cotton blends, etc.). It washes with a gentle action and has a shorter washing cycle compared to the Cottons programme. For curtains and tulle, use the Synthetic 40°C programme with prewash and anti-creasing functions selected. As their meshed texture causes excessive foaming, wash the veils/tulle by putting little amount of detergent into the main wash compartment. Do not put detergent in the prewash compartment.



Steam Option: the steam is perfect for smoothing out creases, refreshing fabrics, neutralizing odors and releasing dirt, destroying allergens more quickly than by washing the item in water.